



Eguana Evolve™

Model
Evolve 0513

Grid Support Utility Interactive Inverter
& Integrated Lithium Battery

❖ Installation & Start-up Guide

For use only with battery model

- LG Chem EM048126P3S7



IMPORTANT SAFETY INSTRUCTIONS

SAVE THESE INSTRUCTIONS

This manual contains important instructions for the Evolve™ Home Energy Storage System – including the power control system (PCS) and base model battery cabinet installation and operation. This product is expandable with the addition of up to two more battery cabinets. The Eguana Evolve™ components described by this manual are intended to be used as part of an Energy Storage system and installed as per the local electrical code.



CAUTION: Hazardous Voltages! This inverter contains hazardous voltage and energy that may be lethal. It may only be installed by qualified personnel who have read this manual and are familiar with its operation and hazards. The following safety procedures should be followed:

Only connect the PCS cabinet to a compatible electrical service as defined in the model specifications. The PCS must be connected to a dedicated branch circuit in the main electrical panel.

An external disconnect switch shall be provided in the end installation by others for the AC Grid output circuit.



CAUTION! This equipment contains high energy lithium batteries. Qualified and trained personnel should wear protective clothing and equipment when working inside the battery cabinet and/or with battery modules.

The PCS is compatible with the LG Chem battery model EM048126P3S7 only.



CAUTION! The batteries provided with this system must be charged only by the PCS included as part of the energy storage system. Do not attempt to charge batteries with any other charger device or connect any devices directly to the DC battery bus.

Ensure proper electrical grounding in accordance with code requirements.

Ensure proper airflow path for active cooling.

Never operate system in a manner not described by this manual.

Only qualified personnel should service this product.

Ensure all covers are securely fastened after installation is complete.

This product must be stored indoors in an environmentally conditioned location prior to installation, protected from rain and exposure to any hazardous chemicals.

Do not attempt to operate this product if there is any physical evidence of damage to any of the cabinets or internal components.









CAUTION! This equipment is heavy. Mechanical lifts are recommended for safe installation.

Contents

1 SAFETY	1
1.1 IN CASE OF EMERGENCY.....	1
1.2 BATTERY MODULE SAFETY PRECAUTIONS.....	1
1.3 GENERAL SAFETY PRECAUTIONS	2
1.4 ENVIRONMENTAL PROTECTION.....	2
2 INTRODUCTION	3
2.1 ABOUT THIS MANUAL – TARGET AUDIENCE	3
2.2 GLOSSARY	3
2.3 INITIAL INSPECTION OF MATERIAL LIST.....	4
2.4 SPECIAL TOOLS & HARDWARE	4
3 INSTALLATION SITE PREPARATION	5
3.1 OVERVIEW OF PCS AND BATTERY COMPONENTS	5
3.2 INSTALLATION AREA REQUIRED TO WALL MOUNT PCS AND BATTERY:.....	5
3.3 INSTALLATION PLAN – POWER AND COMMUNICATION CIRCUITS.....	6
3.4 SLD - AC COUPLED PV SYSTEM WITH BACK-UP POWER OPERATION	7
4 PCS AND BATTERY CABINET WALL-MOUNTING INSTRUCTIONS	8
5 PCS / BATTERY INTER-CABINET WIRING	10
5.1 BATTERY POWER CABLE CONNECTIONS	10
5.2 BATTERY BMS TO PCS COMMUNICATION CONNECTION.....	11
6 SYSTEM ELECTRICAL WIRING	11
6.1 AC POWER CONNECTIONS.....	12
6.2 CHASSIS GROUNDING	13
7 ENERGY METER INSTALLATION	13
7.1 ENERGY METER LOCATION	13
7.2 ELECTRICAL CONNECTIONS – VOLTAGE MEASUREMENT / POWER SUPPLY.....	13
7.3 CT (CURRENT TRANSFORMER) CONNECTIONS	13
7.4 RS-485 COMMUNICATION CONNECTION	14
8 DROPLET ETHERNET CONNECTION TO HOME ROUTER	14
8.1 ETHERNET CABLE CONNECTION.....	14
9 DRED DEVICE CONNECTION: (AUSTRALIA)	14
10 START-UP SEQUENCE	15
11 OPERATION	16
12 PCS DISPLAY PANEL	16
12.1 LED DISPLAY INDICATORS.....	16
12.2 PCS DISPLAY PANEL INDICATOR SUMMARY.....	17
12.3 SERVICE BUTTON	17
13 MAINTENANCE	17
14 TROUBLESHOOTING	18
15 SERVICEABLE PARTS – BATTERY MODULE REMOVAL/REPLACEMENT	18
16 TECHNICAL DATA	19
16.1 PCS CABINET DATA	19
16.2 MASTER BATTERY CABINET DATA	20
16.3 WIRE AND TORQUE RATINGS.....	20
16.4 THERMAL PERFORMANCE: CHARGE / DISCHARGE CURVES	21
APPENDIX A: ELECTRICAL BLOCK DIAGRAM OF INTER-CABINET WIRING	22
APPENDIX B: ENERGY METER WIRING DIAGRAMS	23
B.1 ACCU-ENERGY ACUREV 1310	23
B.1.1 RS-485 Communication to the EMS.....	23
B.1.2(A) Main electrical panel meter CT and power wiring. B.1.2(B) PV meter CT and power wiring.....	23

1 Safety

Throughout this manual, the following symbols will be used to highlight important information and procedures:

Symbol	Definition	Symbol	Definition
	WARNING! A dangerous voltage or other condition exists. Use extreme caution when performing these tasks.		Meter measurement required.
	CAUTION! This information is critical to the safe installation and or operation of the inverter. Follow these instructions closely.		Torque rating critical to operation.
	NOTE: This statement is important. Follow instructions closely.		Login to the remote monitoring system for operating status

1.1 In case of emergency

In all cases:

- If safe to do so, switch off the AC breakers (external to the system) for the system.
- Contact the fire department or other required emergency response team.
- Evacuate the area, and if applicable, follow your emergency evacuation plan if others are in proximity to the installed location.

In case of fire:

- When safe, use a fire extinguisher suitable for use; including A, B, and C dry chemical fire extinguishers or carbon dioxide extinguishers.

In case of flooding:

- Stay out of water if any part of the system or wiring is submerged.
- Do not attempt to operate batteries that have been submerged in water even after they have been dried.

In case of unusual noise, smell or smoke:

- If safe to do so, ventilate the area.

1.2 Battery module safety precautions

This product is integrated with LG Chem EM048126P3S7 series battery modules. Refer to the LG Chem product manual [LG Chem P3S series 48V Standalone Battery Module Installation Manual](#), for complete safety instructions regarding handling of battery modules.

1.3 General safety precautions



Important! Installation, service, and operating personnel must read this document in its entirety, and observe all safety and installation procedures as described in this manual. Never operate system in a manner not described by this manual.

Only qualified personnel should service this product.

Ensure all covers are securely fastened after installation is complete.

Personal Protective Equipment (PPE) in compliance with local work place safety standards must be worn when working inside the cabinet.

Risks of Fire

Do not expose the system to temperatures exceeding 60 degrees Celsius.

Avoid installation in direct sunlight.

Do not store objects on top of the cabinet.

Do not obstruct the intake or exhaust of the forced airflow system.

Do not store combustible objects and corrosive chemicals directly adjacent to the system.

Risks of Shock



WARNING! Hazardous Voltages. The Inverter contains hazardous voltage and energy that may be lethal. It may only be installed by qualified personnel who have read this manual and are familiar with its operation and hazards.

Only connect this product to a compatible electrical service as defined in the model specifications. This product must be connected to a dedicated branch circuit in the main electrical panel.

Ensure proper electrical grounding in accordance with code requirements.



CAUTION! Both AC and DC voltage sources are terminated inside this product. Each circuit must be individually disconnected before servicing.

Risks of Damage



This system is compatible with the LG Chem battery model EM048126P3S7 only. Do not attempt to connect any other battery to the system.

Do not connect any other loads directly to the battery power bus.

Do not drop, tip, or puncture the cabinet during transport and installation. Visible damage to the cabinet and/or internal components should be reported to the manufacturer immediately.

Do not store this system for periods longer than six months without a battery maintenance charge. This may result in permanent damage to the batteries.



1.4 Environmental Protection

Do not dispose of the system or any of the components within the cabinet. Batteries, electronics, cables, and metal parts are recyclable. Consult your municipal waste management authority to determine required methods of component recycling.

2 Introduction

2.1 About this Manual – Target Audience

This manual is intended to be used by qualified service and installation personnel for the purposes of product installation.

This manual contains instructions for the installation and start up sequence of the Eguana Evolve™ home energy storage system; including the PCS and master battery cabinets, the energy meter, and Ethernet connection to a customer supplied internet router. This product is permanently wired to the home electrical service, and must be installed by a licensed electrician only.

The energy management system relies on an AC coupled PV solar source to charge the batteries as part of the energy management control algorithms. A PV solar system must be installed in conjunction with this energy storage system. This product can supply limited backup power, and contains separate grid and load ports to isolate critical loads during a grid outage. When this product is not in service, critical loads are routed directly to the grid panel via the internal PCS bypass relay.

The battery capacity of this system can be expanded by adding additional cabinets adjacent to the master battery cabinet. Expansion of battery capacity is not covered within the scope of this document.

2.2 Glossary

Term	Definition	Term	Definition
AC	Alternating Current	GND	Ground
ARC	Auto Recovery Circuit	LED	Light Emitting Diode
AS/NZS	Standards Australia	NC	Normally Closed
CEC	Clean Energy Council	NO	Normally Open
CPU	Central Processing Unit	PCS	Power Control System (Inverter)
DC	Direct Current	PE	Protective Earth
DRED	Demand Response Enabling Device	PV	Photo-Voltaic
DRM	Demand Response Mode	RF	Radio Frequency
EMS	Energy Management System	SOC	State Of Charge (Battery)
ESD	Electrostatic Discharge	SOH	State of Health (Battery)
ESS	Energy Storage System		

2.3 Initial Inspection of Material List

The system components supplied with your Eguana Evolve™ Energy Storage system are shown below. Each component should be inspected visually for any damage that may have been caused by shipment. If damage is present, please contact your local distributor.



2.4 Special Tools & Hardware

In addition to standard tools, the following tools and hardware should be readily available for the installation.

- Torque wrench
- 17mm socket wrench (battery negative main power connection).
- 10mm socket wrench (battery +/- module power connections).
- 3/8" socket wrench (battery positive main power connection).
- RJ-45 crimp tool (EMS to PCS communication cable) and RJ-45 connectors.
- Mounting hardware for wall bracket (load bearing) – M8 hardware suitable for use with mounting structure.

Item	Description
1	ACB05-LP PCS cabinet
2	ACB05-LB Master battery cabinet
3	Energy meter
4	Current transformer(s)
5	Wall bracket
6	BMS – PCS high level communication cable
7	PCS and battery cabinet levelling brackets
8	Cabinet coupler plates
9	Cabinet coupler gasket
	Cabinet coupler hardware (not shown)
	4 ea M4 bolts
	4 ea M4 star washers
	4 ea M4 lock nuts

3 Installation Site Preparation

Before installing the Evolve home energy storage components, read all instructions and warnings in this manual.



CAUTION! All electrical installation work should be performed in accordance with local building and electrical codes.



WARNING! Isolate the PCS from all energy sources prior to electrical installation by means of disconnects, breakers or connectors. Failure to properly isolate either AC or DC sources may result in serious injury or death. This system will generate an AC voltage at the off-grid terminals when DC source is applied.



CAUTION! The PCS cabinet weighs up to 65 kg, and the battery cabinet weighs up to 102 kg. Handle with care. The wall to which the system is mounted must be load-bearing rated according to the local building code. Mechanical lifts are recommended to position cabinets on the wall bracket.



NOTE: All interconnecting cables are limited in length, and designed specifically for adjacent cabinet mounting using the manufactured wall brackets.



CAUTION! Do not install in direct sunlight. Battery performance is dependent upon operating ambient temperature. Radiant heat absorbed in direct sunlight will greatly reduce the performance of the battery, and will prematurely cause degradation of the display indicator panel on the PCS cabinet. The battery modules are rated for full power operation between -10C to +45C.

3.1 Overview of PCS and Battery components

1. The cabinets can be installed in an indoor and outdoor non-corrosive environment (not marine environment).
2. The forced air cooling of the PCS cabinet is from bottom to top. Refer to figure 1 for recommended layout plan.
3. The PCS and Battery cabinets are rated IP-34. This product requires an installation a minimum of 36" from ground level if installed outdoors.
4. Wall mounting hardware not included. The load-bearing wall bracket is provisioned for M8 hardware. Levelling brackets are provisioned for M5 hardware.

3.2 Installation Area Required to Wall Mount PCS and Battery:

The physical installation of the cabinets requires the layout planning and installation of the system components in the available installation space. The recommended installation height is driven by the viewing angle of the display panel on the PCS cabinet.

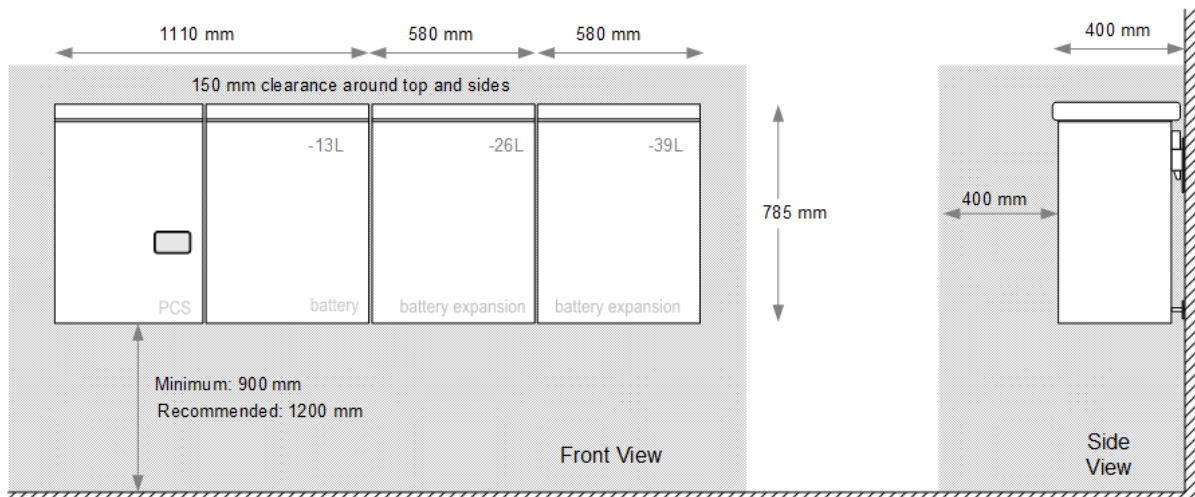

Figure 1: Installation clearances.

3.3 Installation plan – power and communication circuits

The following example outlines the conduit plan for power and communication circuits for the battery system. In this example, the PV inverter is coupled to a backup power sub-panel. The sub-panel may also be an isolated power bus within the main electrical panel.

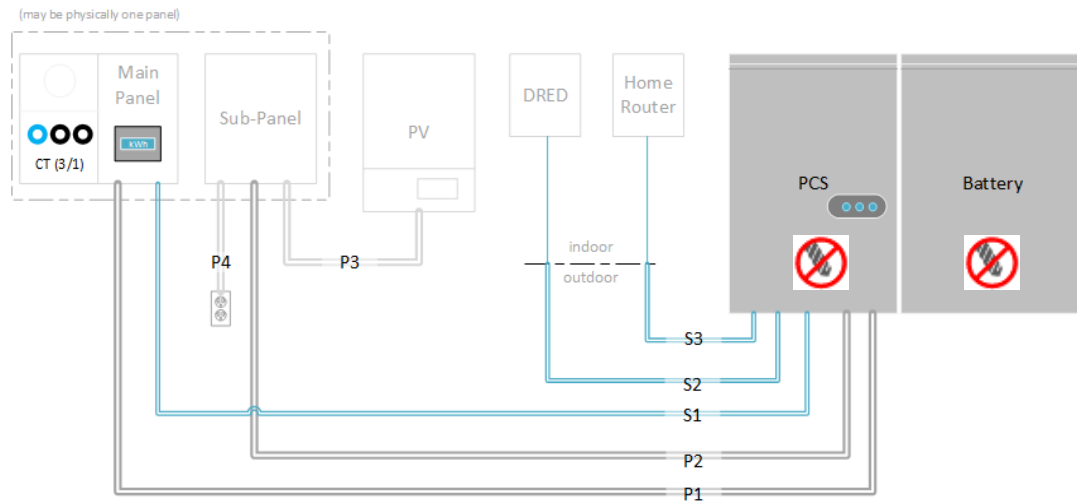

Figure 2: Installation plan.

Signal	Definition	Rating
P1	Grid power*	10 kVA max (5 kVA battery + 5 kVA PV), 230 Vac, 1Ø only
P2	Backup power	5 kVA max, 230 Vac, 1Ø only
P3	PV power (AC), coupled to backup	5 kVA max, AC, 1Ø only
P4	Home load circuit(s), backup power	2 ccts max, 16 A / 230 Vac, 1Ø only
S1	Energy meter (RS-485)	CAT-5, STP
S2	DRED device, Ethernet	CAT-5, UTP
S3	Home router, Ethernet	CAT-5, UTP

* The battery system is rated 5 kVA maximum. Solar self consumption prevents battery power export, however, the grid power circuit must electrically accommodate the total of both battery and PV generation when PV is connected to the backup circuit.

3.4 SLD - AC Coupled PV System with Back-up Power Operation

The single line diagram shown below is a representation of a typical installation configured for utility interactive and back-up power operation, with AC coupled PV connected to a critical load panel. This drawing is a guideline only, and is not a substitute for a code compliant installation. All components required for a code compliant installation are the responsibility of the licensed installer, including any additional circuit protection requirements not shown here.

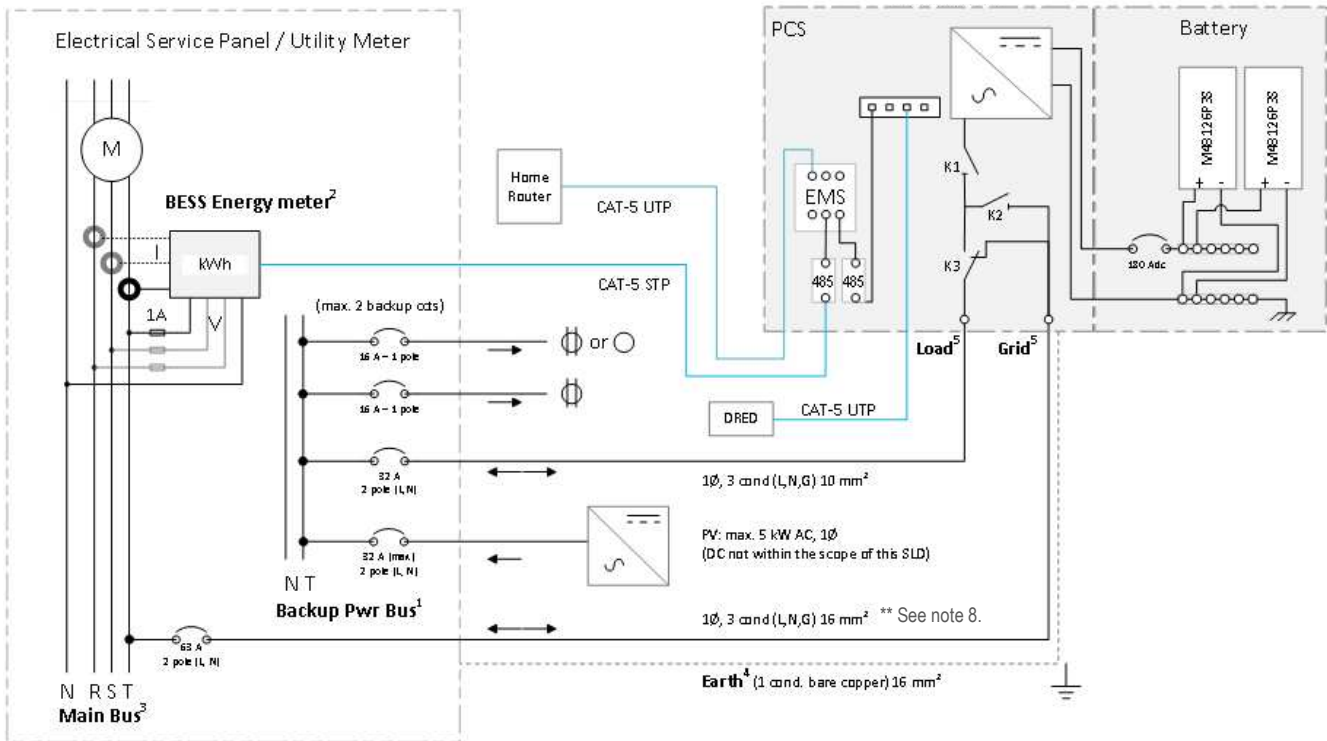

Figure 3: Single Line Diagram: Typical AC coupled PV system.

NOTES

1. The backup power bus must be electrically isolated from the main electrical bus. Do not tap the neutral wires of the main and backup buses. A separate line, neutral, and ground must be run to each of the load and grid ports of the battery system. Refer to the installation manual for wiring details.
2. Energy meter supports 1Ø and 3Ø configuration.
3. 3Ø service shown. For 1Ø service, do not populate R,S ph components.
4. The battery system must be earth bonded to the building ground to meet lightning protection requirements.
5. The battery system load and grid ports are independently controlled circuits. Should the electrical code require additional "line-of-sight" disconnects, a separate disconnect must be used for each of the grid and load ports. The disconnects and/or circuit breakers must operate independently of each other, and not be ganged.
6. The PCS provides galvanic separation of AC and DC sources. Overcurrent protection devices, RCD Type A, are sufficient for protection of both AC Grid and AC load ports.
7. Total AC nameplate of PV not to exceed 5 kW. String inverter shown for simplicity. Multiple AC strings of micro-inverters permitted. Any additional PV installed on the grid side of the battery system operates independently from the battery system, and is only limited by the interconnection requirements of the utility service provider.
8. The maximum conductor size permitted for the PCS grid port is 16 mm², and maximum breaker rating of 63 Amp to protect the internal circuits of the PCS. The ESS breaker rating and conductor size can be reduced, however, these parameters are subject to the total possible continuous output current of combined PV and ESS generation at the ESS grid breaker in the main electrical panel. Variables that determine conductor sizing include; PV continuous output current rating connected to the ESS load terminal, total self-supply current to the main electrical panel (load connected PV plus ESS output), and length of run from the ESS grid port to the main electrical panel (voltage drop). Conductor sizing is the responsibility of the installer as per the actual installation, compliant to local / national electrical codes.

*DRED: Australia only.

4 PCS and Battery Cabinet Wall-Mounting Instructions



1

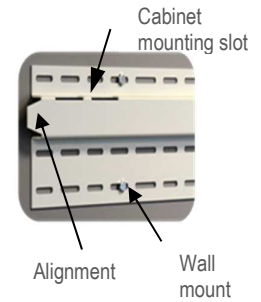

1. Mount the wall bracket to the wall. Use the available slot pattern to mount to a load-bearing structure rated for the weight of the final system. The slots accommodate a M8 bolt diameter.



IMPORTANT! *Wall-stud mounting:* A minimum of three wall studs spanned within the width of the mounting bracket are required. A minimum of two mounting bolts are required per stud (top/bottom).

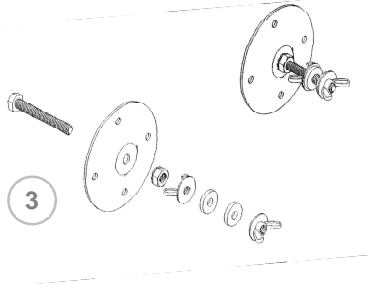

3

2. Remove the master battery cabinet from the packaging, and stand the cabinet upright. (not shown). Remove the front cover.
3. Assemble the lower leveling bracket. (Fully assembled drawing shown – the last washer and wing nut are mounted from inside the cabinet).

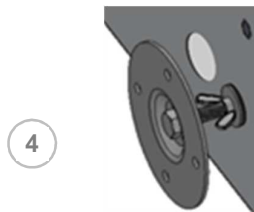

4

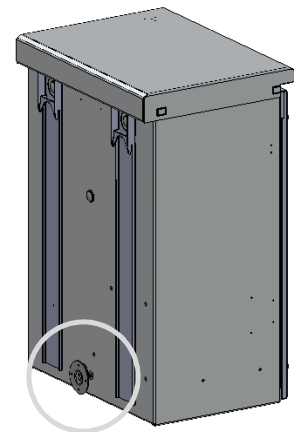

4. Mount the leveling bracket to the cabinet.



CAUTION! Battery cabinet is heavy. Mechanical lift recommended.

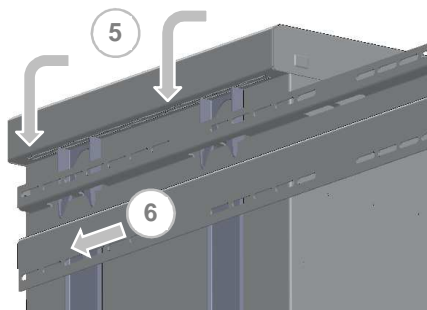

5

5. Lift the battery cabinet onto the wall mount bracket, aligning the wall hooks at the rear of the cabinet with the slots on the load-bearing face of the bracket.



6

6. Slide the battery cabinet towards the right end of the bracket to allow for clearance for the PCS cabinet.

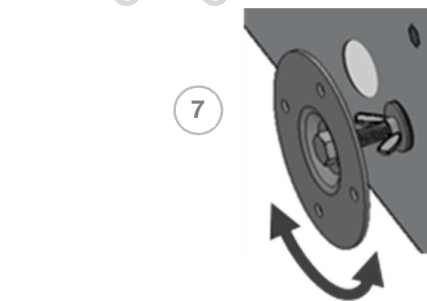

7

7. From the rear side of the cabinet, spin the lower levelling bracket (in/out) until the cabinet is vertically plumb (level) to the wall.

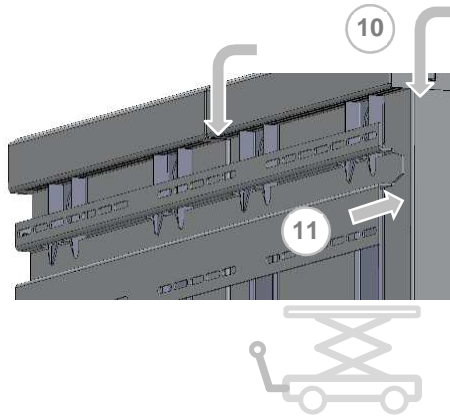

Figure 4: Wall mount bracket and battery cabinet installation.

8. Remove the PCS cabinet from its packaging and stand upright. (not shown). Remove the front cover.
9. Assemble and mount the leveling bracket as shown in steps 3 and 4 above.



CAUTION! The PCS cabinet is heavy. Mechanical lift recommended.



10. Lift the PCS cabinet onto the wall mounting bracket.
11. Slide the PCS cabinet to the left such that it aligns with the alignment tab on the mounting bracket.
12. From the rear side of the cabinet, spin the lower levelling bracket (in/out) until the cabinet is vertically plumb (level) to the wall (as shown in step 7).



WARNING! The mounting bolts of the flange assembly are required to be fully secured, as they provide the chassis grounding for the battery cabinet. Torque nuts as specified in the specification tables provided in this manual.

13



14



13. Insert the PCS cabinet coupling gasket between the two cabinets (lower-front). Slide the battery cabinet towards the left until mating to the gasket.
14. Place the coupling plate inside the PCS cabinet and insert the four mounting bolts and washers through to the battery cabinet side.
15. Place star washers on the bolts on the battery side of the cabinet.
16. Mount the battery cabinet side coupling plate, and fasten with the lock nuts.

15



16



17. **Continuity test:** Check the continuity between the cabinets using an Ohm meter. The test reading must be zero Ohms at a bare metal point inside each of the PCS and battery cabinets.
18. Optional: (This is not a load bearing anchor – anchored conduit runs to the PCS are satisfactory). Install screws in leveling plates for PCS and battery cabinets by inserting a screwdriver through the hole on the backside of the cabinets.

18

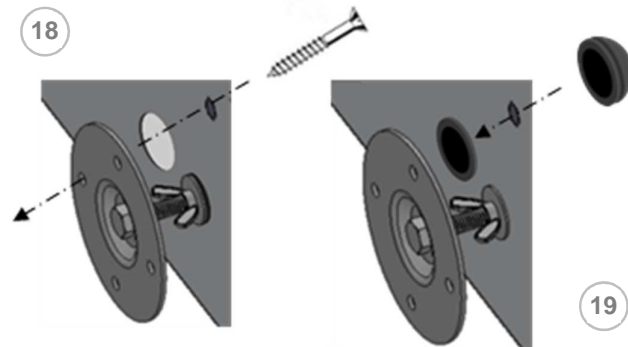

19

19. Plug hole on back of cabinet using by inserting the hole plug from the front side.

Figure 5: PCS cabinet installation and inter-cabinet coupler assembly.

5 PCS / Battery Inter-Cabinet Wiring

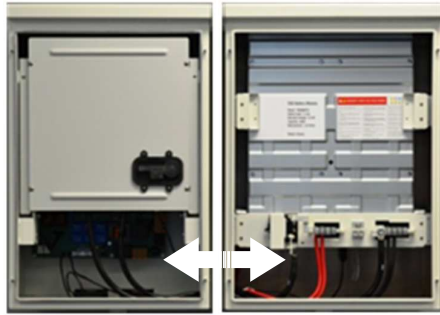

The following instructions cover the interconnection wiring of the PCS and master battery cabinet. No cable preparation is required with battery modules pre-installed in the cabinet. Refer to appendix A for a complete inter-cabinet wiring diagram.



Note: Overcurrent protection of the DC source is provided internally as part of the integrated battery system. No external DC disconnect is required.

5.1 Battery power cable connections



CAUTION! A torque wrench is required to ensure the power cables are terminated to their specifications. Over-torque can damage the DC breaker and/or strip the threads on the copper bus bar posts. Under-torque can result in an arc fault hazard, and risk of fire. Damage as a result of improper termination is not covered by the manufacturer warranty.

1. Remove the plastic safety barrier on the power panel assembly inside the master battery cabinet by removing the three white plastic lug nuts on the top of the safety barrier.
2. Route the battery cables from the PCS cabinet to the battery cabinet.
3. Loosen the PCS DC- terminal bolt using a 17mm socket wrench. Remove the ground cable.
4. Place the DC- cable and ground cable ring terminals back-to-back, and mount them to the PCS DC- bus bar. Tighten the bolt using the 17mm socket. Torque to 6.8 Nm.
5. Connect the Battery positive (+) cable to the PCS Batt+ bus bar terminal on the rear of the battery disconnect switch using a 3/8" socket wrench. Torque to 4.0 Nm.

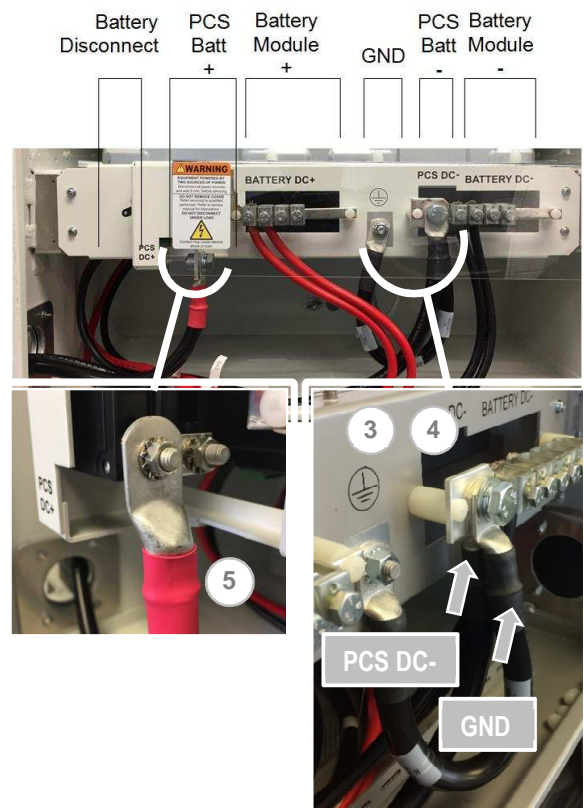

Figure 6: Battery power cable installation.

5.2 Battery BMS to PCS communication connection

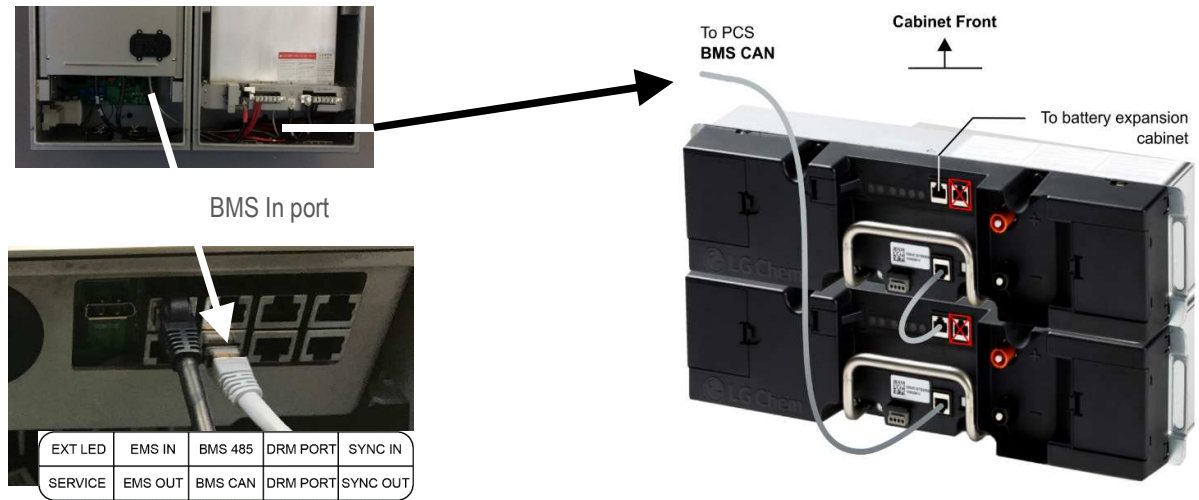

Figure 7: PCS to BMS communication wiring.

The communication cable can be routed with DC power cables. Take care that the communication cable is routed through the inter-cabinet coupler so that there is no stress or tension on the terminations. This cable is terminated with RJ-50, 10-pin connectors.

1. PCS cabinet: Terminate the cable (p/n 801003338) at the **BMS CAN** port, as shown in figure 7, above-left.
2. Battery cabinet: Terminate the cable at the rear battery module BMS port as shown above-right.

6 System Electrical Wiring



Note: This product is capable of providing utility interactive and islanded back up power, and can be AC coupled to a utility interactive photovoltaic inverter. Wiring methods must be in accordance with local electrical codes. The installer is responsible for ensuring that over-current protection is installed and sized appropriately for the AC grid and off-grid output circuits, in accordance with the AS/NSZ electrical code.

All field wiring connections to the battery system are at the PCS cabinet only. The diagram (left) indicates the knockout locations for conduit entry into the PCS; categorized as AC power and signal level circuits.



IMPORTANT! Drilling holes anywhere in the battery or PCS cabinet renders the warranty null and void. Use the knockouts provided at the bottom face of the PCS cabinet only! Do not drill holes anywhere in the battery system. Use conduit fitting reducers, if applicable.

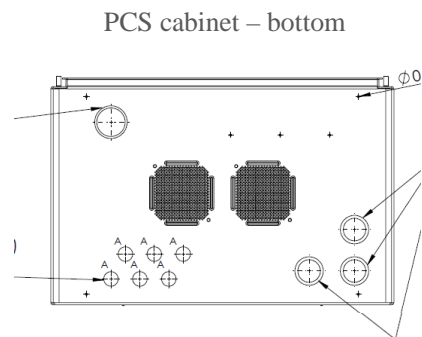

Figure 8: PCS knockout pattern.

6.1 AC power connections

This battery system contains two independent AC power connection ports; one port dedicated for an electrical utility connection, marked “AC Grid”, the other port dedicated for backup operation, marked “AC load”. This product’s primary application is intended for utility interconnection, and must be connected to a utility electrical service supplying single phase 230 Vac / 50 Hz. The backup operation of this product is a secondary application, and is intended to supply emergency backup operation only. Under no circumstances should this product be used solely as an off-grid storage system, nor should it be expected to perform whole home emergency backup power.



Note: The PCS provides galvanic separation between AC and DC Sources. RCD protective devices of Type A are sufficient for use as circuit over-current protection for both AC Grid and AC Load ports.



CAUTION! To reduce the risk of fire, connect only to a dedicated circuit provided with appropriate branch circuit over-current protection in accordance with local electrical codes.



WARNING! Improper connection of the wiring panel may result in equipment damage and cause personal injury. Disconnect all AC and DC Sources prior to installation.



CAUTION! The AC grid and load ports are independent circuits, controlled internally by an automatic bypass and transfer switch. Each port must be connected to electrically isolated panels. Tapping line or neutral wires from the main electrical panel to the backup panel will result in permanent damage to the product.

1. **AC Grid Port:** Open the spring clamp terminals on the AC circuit board at the port marked “AC Grid”.
2. Terminate the AC grid connection wires as follows: “L_Grid” = Line, “N_Grid” = Neutral, and “PE” = Ground
3. Close the spring clamp terminals, ensuring levers are fully engaged.
4. **AC Load Port:** Open the spring clamp terminals on the AC circuit board at the port marked “AC Load”.
5. Terminate the wires at “L_AC load” (Line), “N_AC load” (neutral), and “PE_AC load” (protective earth).
6. Close the spring clamp terminals, ensuring levers are fully engaged.

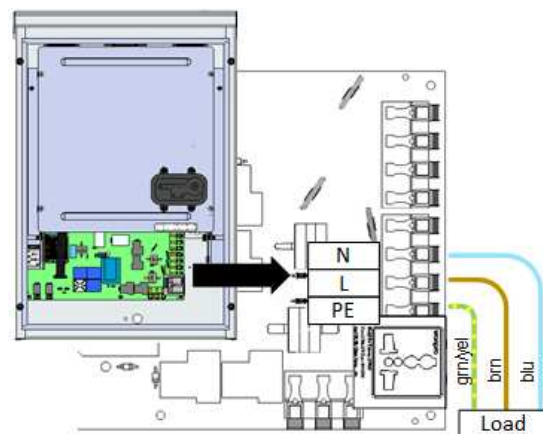
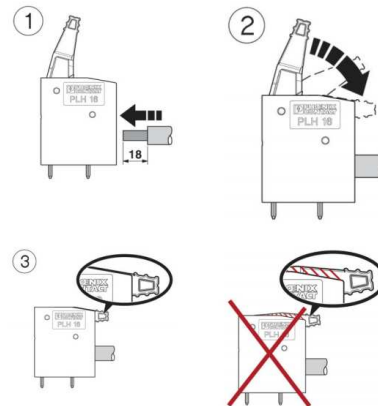
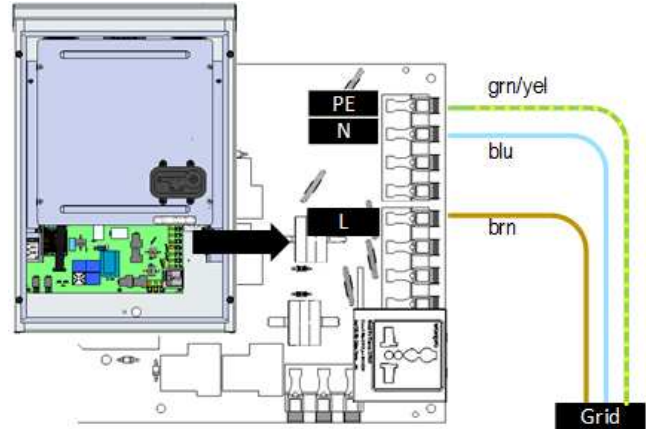

Figure 9: Wiring the PCS AC grid and load ports.

6.2 Chassis Grounding

In this section, “Chassis Ground” is referred to as “ground” or “grounding” unless otherwise mentioned. The AC and DC grounding are intended to provide a low impedance signal path at all frequencies.

DC Ground Wiring Installation: The PCS cabinet is shipped with ungrounded DC power terminals within the inverter. However the default setting for DC grounding is set for DC negative to ground. This is to indicate that the DC negative terminal of the inverter is grounded within the PCS system. The DC negative ground is completed once terminated in the master battery cabinet, as the battery module DC bus is pre-wired with negative grounded battery modules. .

AC Ground Wiring Installation: The AC power grounding is achieved through the PE terminals of the AC grid connectors on the AC Filter Board, as shown in section 6.1.



Note: The field ground wire rating applies to the AC circuit only. The DC source loop is internal to the battery cabinet, and is rated accordingly.

Lightning Grounding: The inverter has built-in lightning protection. In order for the lightning protection to be effective, the grounding for lightning currents must be provided via low impedance path from AC Filter Board to System Ground and further to the building Ground/Earthing point.

7 Energy meter installation

The energy management system’s solar self-consumption algorithm requires the connection of an energy meter at the customer’s main electrical panel. The meter must be installed and configured according to the electrical service; either single phase or three phase. The information covered in this guide is generic to the approved list of integrated energy meters that are supported by the home storage system at the time of your purchase. Refer to the energy meter manufacturer’s installation manual supplied with your system for full installation details and safety information.



Note: Refer to Appendix B for wiring diagrams specific to the manufacturer and model of the energy meter supplied with your system.

7.1 Energy meter location

The meter supplied must be installed inside or near the home’s electrical service panel. CT’s supplied with the meter are provided with standard 2.4 meter length wires. The meter must be located such that the CT’s can be terminated without extensions. If there is no room inside the electrical panel, the meter should be installed adjacent to the panel in an enclosure rated for the environment in which it is installed. Energy meters supplied with the home storage system are DIN rail mounted. Use existing DIN rail space within the electrical panel, or add DIN rail as required.

7.2 Electrical connections – voltage measurement / power supply

The energy meter provided with your system is line powered from the electrical service. An in-line fuse, rated 1 Amp / 250 VAC, is required on the voltage line input to the meter. For three phase service, fuses are required on the V1, V2, and V3 input terminals. The neutral connection does not require a fuse. The voltage inputs can be connected anywhere on the customer side of the main service disconnect breaker. For three phase systems, phase rotation is automatically configured by the meter.

7.3 CT (current transformer) connections



Note: Observe the current flow direction of the CT. The direction of flow must be away from the utility meter. For three phase systems, phase rotation is automatically configured by the meter for your convenience.



CAUTION! Handle CTs with care. Always terminate the CTs at the meter inputs prior to clamping the core onto a hot wire.

This system is supplied with split-core CTs for installation without interruption to the electrical service. The CTs must be mounted on the primary electrical bus, between the main service breaker disconnect and the utility's energy meter. This is important to ensure all loads and generation are captured for optimum performance of the solar self consumption control algorithms.

7.4 RS-485 communication connection

The battery system communicates with the meter using the Modbus protocol over an RS-485 network. Shielded twisted pair cable is required.



Note: Shield wire connected to earthing terminal at a single point only.

Terminate the cable as shown (TIA/EIA 568B standard):

Signal	RJ-45 Pin	Wire color
GND	3	green/white
A	4	blue
B	5	blue/white

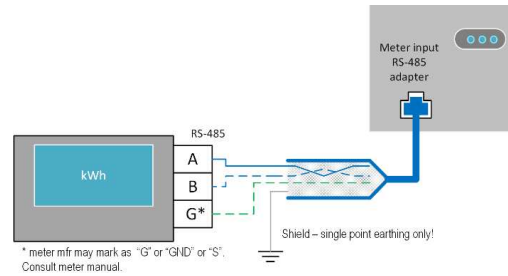
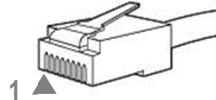

Energy meter input



Figure 10: Meter communication connection.

8 Droplet Ethernet connection to Home Router

A Wi-Fi connection to the battery system is permitted for remote monitoring of the system, however, a permanent connection is strongly recommended for reliable communication access to the system. The Ethernet wiring from the battery system must be connected to a customer supplied router.

A permanent Ethernet connection to the battery system requires external wiring. Compliance with local electrical code is the responsibility of the installer. Conduit and fittings connected to this equipment must ensure compliance with the IEC environmental rating as per the equipment ratings.

8.1 Ethernet cable connection

The Ethernet connection is a standard RJ-45 straight through configuration. Standard EIA/TIA termination practices are recommended.

1. Remove the knockout dedicated for the Ethernet connection.
2. Secure the communication cable strain relief (conduit fitting, if applicable).
3. Terminate the routed cable as a straight-through Ethernet connection.
4. Test the cable prior to connection.
5. Connect the cable to the Droplet's Ethernet port as shown.



Figure 11: Droplet Ethernet connection.

9 DRED Device Connection: (Australia)

1. Connect the DRED device to the DRM Port at the PCS communication interface card.

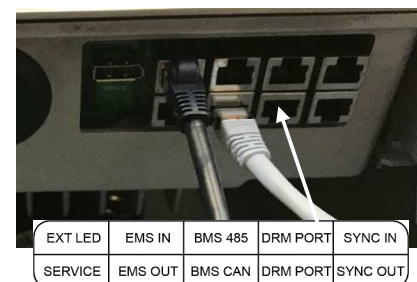

Figure 12: DRED device connection.

10 Start-up Sequence



CAUTION! Powering the Evolve home energy storage system requires a specific start-up procedure. Please follow the steps below.



CAUTION! If the battery disconnect has been placed in the OFF position at any time during operation, wait one minute before returning to the ON position. Rapid cycling (less than one minute) of the battery disconnect can cause damage to the pre-charge circuit.



CAUTION! During the first start-up sequence after installation, the battery modules may require a battery maintenance cycle to balance the SOC. This maintenance cycle requires a grid connection so that the PCS can be commanded to charge the batteries. The PCS battery SOC alarm light will flash yellow if maintenance and/or other battery faults are present. This procedure may take from a few minutes to a few hours, depending on the difference in battery module SOC. Please refer to the PCS Service Manual for more information.

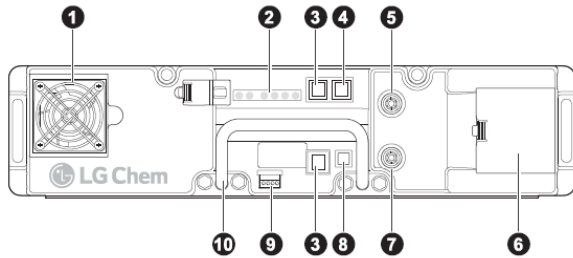

- ❶ Fan
- ❷ Status indicators
- ❸ RJ48 port for intra-rack communication cable
- ❹ RJ48 port for higher-level communication cable
- ❺ Positive connector (+)
- ❻ Power terminal compartment
- ❼ Negative connector (-)
- ❽ On/Off button
- ❾ Dry contact
- ❿ Handle

Figure 13: Battery module feature list.

Remove the front cover from the battery cabinet adjacent to the PCS cabinet.

Press the [Power] button (see above, label #8) on the master battery module. The master battery module has communication wired from the battery BMS port (label #4) to the PCS [BMS in] port.



WARNING! When the batteries are turned ON, the battery voltage will be present at the power panel assembly bus bar where the battery modules are terminated.

This step may take up to one minute.

Verify that the indicators are as shown in “Normal Operation” as shown below.

●	○	○	○	○	○	Normal
●	○	●	●	●	●	SOC ≥ 75%
●	○	○	●	●	●	SOC ≥ 50%
●	○	○	○	●	●	SOC ≥ 25%
●	○	○	○	○	●	SOC < 25%
●	●	○	○	●	●	Voltage imbalance
☀	○	○	●	●	●	Warning
○	☀	○	○	○	○	Fault 1
○	●	○	○	○	○	Fault 2

Battery Power Button Operation

WARNING! The master battery turns on the slave battery modules in the battery rack via the communication network. Do not use power buttons to turn each module on individually. This may cause damage to one or more batteries on the DC bus.

Turn Batteries ON: Press and Release the power button on the module designated as the Master module (PCS connected com cable).

Turn Batteries OFF: Press and hold 5 seconds the power button of any module designated as a Slave Module. If all modules do not shut off, repeat individually for each module.

Green indicator: The left indicator indicates normal operation.



Blue indicators (SOC): In normal operation, the four indicators on the right show the module's state of charge (SOC). Each indicator represents 25% of a full charge. If the SOC value is 50%, the three rightmost indicators are on solid BLUE. The blue indicators of the slave modules look as below.

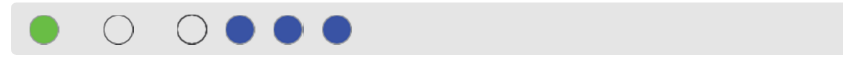

Whereas, the leftmost blue indicator on the master module flashes.

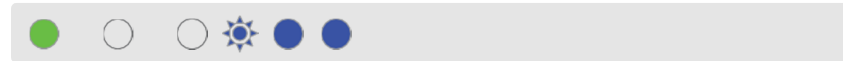

Also, verify that the module with the left-most flashing blue SOC indicator corresponds to the module which has communication wired from the BMS to the PCS [BMS in] port.



Caution! If the battery module other than the module designated as a master has a flashing SOC light at startup, shut down all battery modules by holding the [Power] button for 5 seconds. In this state, it may be necessary to shut down battery modules individually. After all modules are OFF. Repeat steps 2 and 3.

1. Turn ON the Battery disconnect switch inside the battery cabinet.

The PCS module will initialize, indicated by a brief flash of all LEDs on the display panel, followed by a status of the battery and PCS. Refer to table in section 12.2 for definitions of the indicator status of the PCS.

2. Turn ON the AC breaker at the main electrical panel to the PCS.



Figure 14: Battery breaker disconnect turn ON.

11 Operation



The Evolve home energy storage system is fully automated. The EMS will be programmed to connect the system to the grid after AC and DC sources are applied. Refer to the user interface manual for system monitoring and operation status. The operating states can also be viewed on the PCS display panel.

12 PCS Display Panel

12.1 LED Display Indicators

The PCS cabinet is equipped with a display panel that provides indication of the following:

- Battery Operating State
- PCS Operating State
- (out of) Service Indicator

Refer to section 12.2 for a complete definition of indicator states.

To conserve energy, the LEDs will turn off after 5 minutes from being activated. They can be re-activated by pressing the service button.

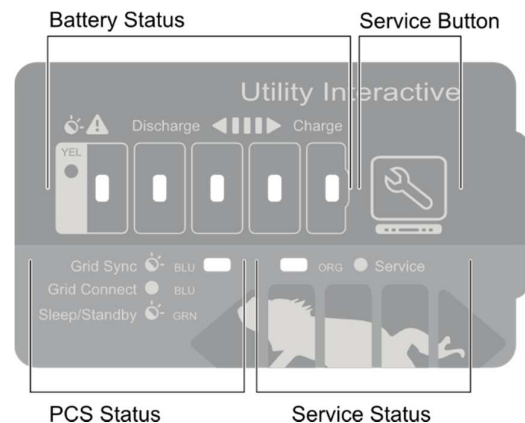

Figure 15: PCS display panel.

12.2 PCS display panel indicator summary.

The LEDs on the PCS identify operating states by both display mode and color.

The display mode patterns (shown right) are defined as:

- Blink: short ON, long OFF
- Flash: equal ON/OFF
- Solid: steady ON

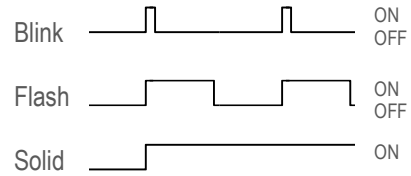

Indicator	Status	Display mode	Display Color
Battery Status	State of charge	(L-R): 5 LEDs, 20% SOC per LED	Green >20%, Yellow <20%
	Initialized	One time blink	Multi
	Charging	Flashing pattern - right	Green
	Discharging	Flashing pattern - left	Green (Yellow <20%)
PCS Status	Sleep/Standby	Blinking pattern	Green
	Pre grid-connect notification	Flashing pattern	Blue
	Grid connected	ON	Blue
	Off-grid mode	ON or Blinking pattern	Green/Yellow
Service Status	Service	ON	Orange
	Programming mode	ON	Green
	Active sleep	Blinking pattern	Green
	Pre-charge	Blinking pattern	Green
	DC Ground Fault	Blinking pattern	Yellow
Auto-Recovery	All lights rapid blinking – See section 14 for more details.		

12.3 Service Button

The service button can be used to wake the LED display, and either place the system into or out of service mode, as well as cycle through various operating modes. If the system has gone into service mode, the user can attempt to bring the system back into normal operation using the service button.



Note: It is recommended to login to the EMS via web browser and retrieve the service code from the system prior to attempting to clear the service mode.

Observed state	Action	Service button command
All panel lights off	Wake panel display	Press and release
Service light on	Exit service mode	Press and hold 5 seconds

Refer to *section 14 – Troubleshooting* if the service button does not perform the action requested.

13 Maintenance

The Evolve home energy storage system is a maintenance free product. Regularly scheduled inspection of the airflow path for the active cooling fans on the bottom side of the PCS cabinet is all that is required. This inspection should occur on an annual basis, or coincide with PV inspection.

If the fan ventilation holes are obstructed with dust / debris, a soft-bristled brush can be used to wipe them clean. For heavy soiling use a soft, dry brush. Do not use any solvents, scouring, or corrosive materials to clean the unit. Never remove or unplug connections or plugs during cleaning.

14 Troubleshooting

System faults are reported and logged in the monitoring system. All fault logs are also accessible remotely by your installer.



IMPORTANT! Contact your system installer immediately if any of the following conditions are present on the front display of the inverter panel.

PCS indicator status	Definition
Service light ON	System is prevented from normal operation due to internal fault.
All panel lights flashing	System is attempting battery recovery. Notify service personnel if this condition persists more than 30 minutes.
All panel lights OFF after press/release of service button	This indicates loss of both AC And DC sources to the PCS.
Sleep/standby mode engaged	This is a normal operating mode initiated by the EMS when the battery SOC reaches the maximum or minimum SOC. Loss of EMS communication will also engage the PCS into sleep/standby mode. If on initial power up of the system, the PCS does not exit sleep/ standby mode, and one to four battery SOC lights are ON, inspect the EMS to PCS communication cable , and verify that the EMS is powered.

15 Serviceable Parts – Battery module removal/replacement

The battery modules within the battery cabinet are removable and/or replaceable. To replace or remove the battery modules:

1. Follow section 5 in this manual to disconnect the inter-cabinet cabling.
2. Refer to the 68006 Battery Module Field Assembly Guide for instructions on removing the battery modules. Assembly and disassembly are the reverse order.

16 Technical Data

16.1 PCS cabinet data

Electrical & performance data, AC	
Grid voltage	230 / 240 Vac
Grid frequency	50 Hz
Maximum continuous operating current (or Rated current), AC	21.7 Amps
Maximum continuous operating power (or Rated power), VA	5000 VA
Power factor, nominal (range)	> 0.99 (0.8 lead to 0.8 lag)
Efficiency, % peak (average)	96 (94.5)
Maximum AC fault current and duration (short circuit)	248 Apk, 7.97 Arms for 0 to 50ms
Inrush current	0 Amps
Galvanic isolation	transformer
AC connections, number (type)	2 (grid, backup)
Maximum output overcurrent rating, grid & backup connection	63A maximum
PV solar coupling method	AC only (PV inverter not included)
PV power limit, AC only, backup connection	5000 VA
PCS self consumption power, sleep (operating)	6.4 W (30 W)
Backup power surge rating	170 %, 3 seconds
Lightning protection	IEEE 62.41.2, location category B, low exposure
Active anti-islanding method	Sandia frequency shift
Protective Class (I, II, or III)	Class I
Over-Voltage Category (OVC I, II, III, or IV)	OVC III
Pollution Degree	3
Electrical data, DC	
Nominal DC Voltage	48 V
DC Voltage Range	40 to 66 V
Maximum DC Current	Discharge = 125 A / charge = 100
Storage Type	Lithium, Lead Acid, other
General data	
Width	529 mm
Depth	397 mm
Height	783 mm
Weight	65 kg
Protection type	IP34
Ambient temperature, relative humidity, altitude	-40 °C to +50 °C, 95%, 2000 m
Cooling method	Fan, thermostat control
Installation type	Wall-mount (upright)
PV solar coupling method	AC only (PV inverter not included)
DRED device support	DRM 0 to DRM 9 (all DRM modes supported)
Ground fault monitoring	DC negative grounded
Lightning protection	IEEE 62.41.2, location category B, low exposure
Display	LED: battery SOC, grid connect state, service state

16.2 Master battery cabinet data

Electrical and performance data	
Battery module, manufacturer	LG-Chem
Model	EM048126P3S7
Chemistry	Lithium NMC
Rated energy, per module	6.5 kWh
Number of modules per cabinet	2
DC voltage operating range	42.0 to 58.5 Vdc
Battery lifetime energy guarantee, per module	19.2 MWh
Circuit protection, integrated	Breaker, 180 Adc, positive pole
Battery module bus bar connection	6 battery module connections max. (2 expansion battery cabinets supported)
General data	
Width	572mm
Depth	397mm
Height	783 mm
Weight, including two battery modules	103 kg
Protection type	IP34
Ambient temperature, relative humidity, altitude	-10°C to +45°C, 95%, 2000 m
Cooling method	Convection
Installation type	Wall-mount (upright)

16.3 Wire and torque ratings

Use solid copper only, 90 °C or higher rating

PCS (AC)	# conductors	AWG	Torque
AC grid	2 conductor + PE	10 mm ² to 16 mm ²	Push-lock, spring cage
AC load	2 conductor + PE	10 mm ² to 16 mm ²	Push-lock, spring cage
Ground Lug	1 conductor	16 mm ²	5.0 Nm

Battery (DC)	# conductors	AWG	Torque
PCS battery + lug	included	70 mm ²	4.0 Nm
PCS battery - lug	included	70 mm ²	6.8 Nm
Ground Lug (internal)	included	70 mm ²	5.7 Nm
Battery module (+/-)	included	50 mm ²	4.2 Nm
Ground Lug (field connection)	1 conductor	16 mm ² to 70 mm ²	6.8 Nm

16.4 Thermal performance: Charge / Discharge Curves

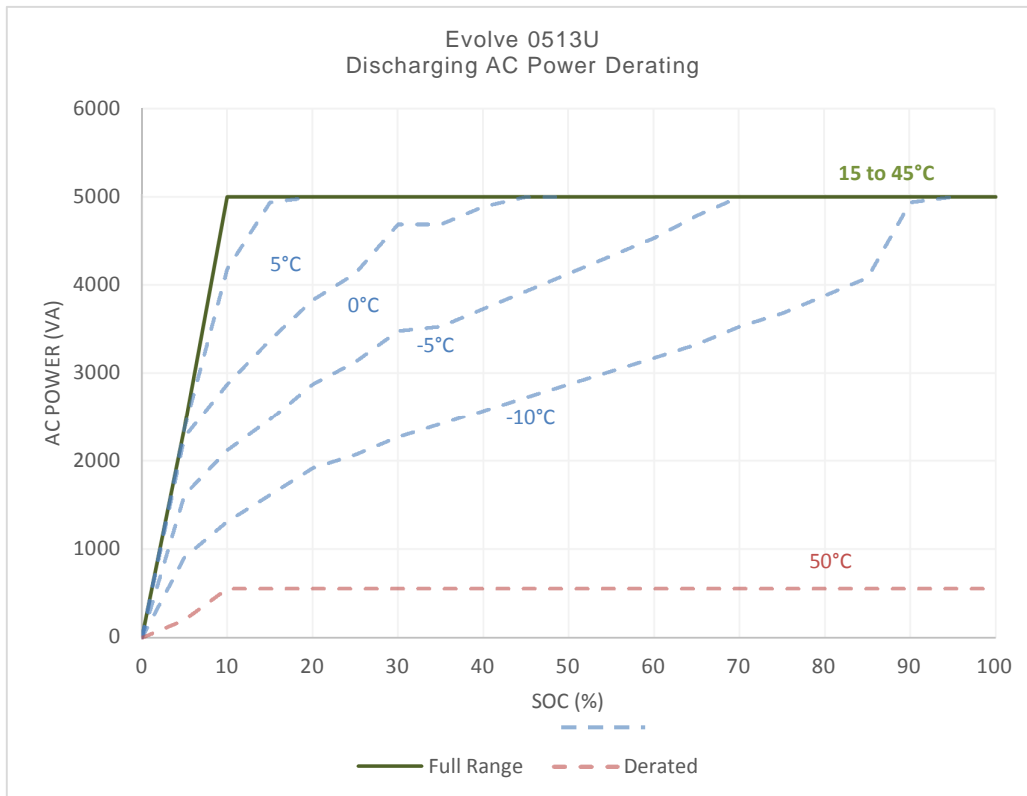
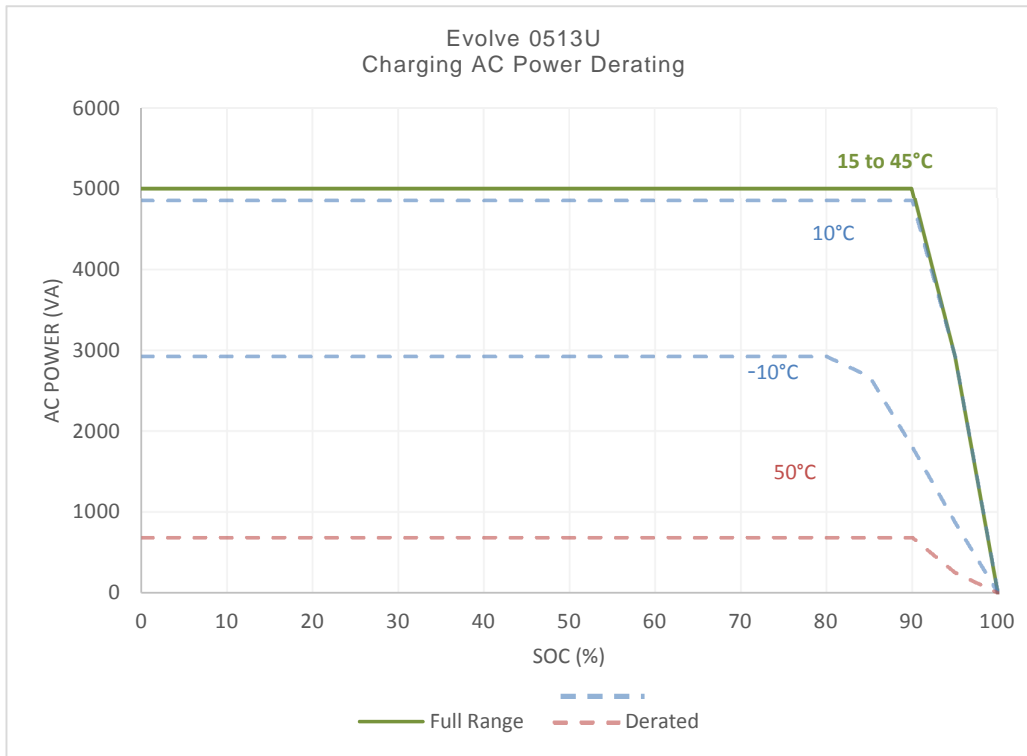

Figure 16: Energy storage system thermal derated charge and discharge curves with base (13 kWh) battery cabinet.

Appendix A: Electrical Block Diagram of Inter-Cabinet Wiring

The following reference diagram outlines the DC and communication interconnections between PCS, master battery, and expansion battery cabinets.

Reference	P/N	Title	Notes
A1	801003338	PCS-BMS cable	Connects master battery to PCS [BMS CAN] port.
A2	801003533	BMS cable – short	Interconnects modules within same cabinet.
A3	801003247	BMS cable – long	Interconnects modules between cabinets.
A4	-	Battery power cables	Positive / negative pair

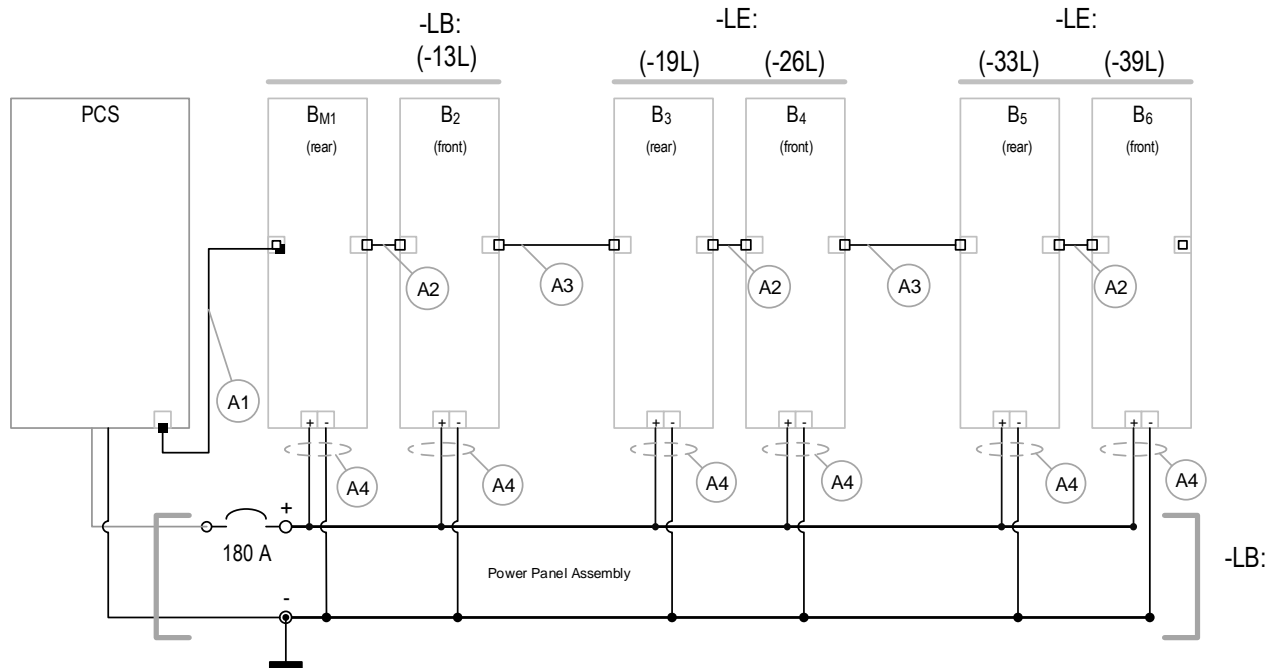

Figure 17: Electrical block diagram of the Evolve home energy storage system, including -LB / -LE cabinets with inter-cabinet wiring references.

Appendix B: Energy Meter Wiring Diagrams

B.1 Accu-Energy Acurev 1310

B.1.1 RS-485 Communication to the EMS

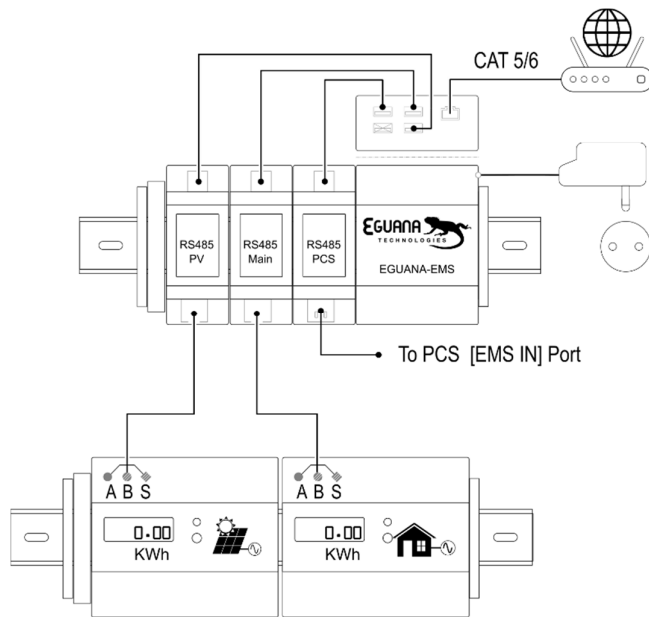

Figure 18: EMS to Acurev 1310 energy meter communication wiring diagram.

B.1.2(A) Main electrical panel meter CT and power wiring. B.1.2(B) PV meter CT and power wiring.

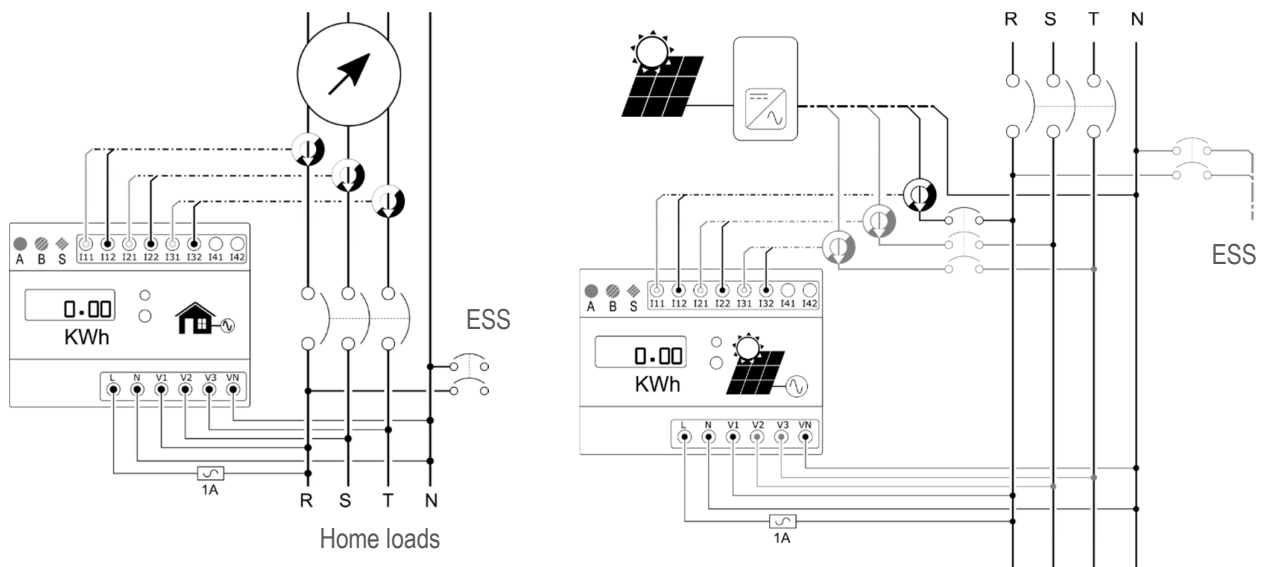

Figure 19: A) Acurev 1310 main panel meter, and (B) PV meter CT and power wiring.

THIS PAGE INTENTIONALLY LEFT BLANK